



JBL CINEMA SB140



OWNER'S MANUAL

IMPORTANT SAFETY INSTRUCTIONS

Verify Line Voltage Before Use

The JBL CINEMA BAR 140 (soundbar and subwoofer) has been designed for use with 100-240 volt, 50/60 Hz AC current. Connection to a line voltage other than that for which your product is intended can create a safety and fire hazard and may damage the unit. If you have any questions about the voltage requirements for your specific model or about the line voltage in your area, contact your retailer or customer service representative before plugging the unit into a wall outlet.

Do Not Use Extension Cords

To avoid safety hazards, use only the power cord supplied with your unit. We do not recommend that extension cords be used with this product. As with all electrical devices, do not run power cords under rugs or carpets, or place heavy objects on them. Damaged power cords should be replaced immediately by an authorized service center with a cord that meets factory specifications.

Handle the AC Power Cord Gently

When disconnecting the power cord from an AC outlet, always pull the plug; never pull the cord. If you do not intend to use this speaker for any considerable length of time, disconnect the plug from the AC outlet.

Do Not Open the Cabinet

There are no user-serviceable components inside this product. Opening the cabinet may present a shock hazard, and any modification to the product will void your warranty. If water accidentally falls inside the unit, disconnect it from the AC power source immediately, and consult an authorized service center.

TABLE OF CONTENTS

IMPORTANT SAFETY INSTRUCTIONS	2	8 RESTORE FACTORY SETTINGS	12
1 INTRODUCTION	4	9 SOFTWARE UPDATE	12
2 WHAT'S IN THE BOX	4	10 PRODUCT SPECIFICATIONS	13
3 PRODUCT OVERVIEW	5	11 TROUBLESHOOTING	13
3.1 CONTROLS AND INDICATORS	5		
3.2 CONNECTORS	5		
3.3 SUBWOOFER	6		
3.4 REMOTE CONTROL	6		
4 PLACE	7	12 TRADEMARKS	14
4.1 DESKTOP PLACEMENT	7		
4.2 WALL-MOUNTING	7		
5 CONNECT	8		
5.1 TV CONNECTION	8		
5.2 BLUETOOTH CONNECTION	8		
6 PLAY	9		
6.1 POWER-ON/AUTO STANDBY/AUTO WAKEUP	9		
6.2 PLAY FROM THE TV SOURCE	10		
6.3 PLAY FROM THE BLUETOOTH SOURCE	10		
7 SOUND SETTINGS	11		
7.1 PRE-DEFINED EQ SETTINGS	11		
7.2 VOICE MODE	11		

1 INTRODUCTION

Thank you for purchasing the JBL CINEMA BAR 140 (soundbar and subwoofer) which is designed to bring an extraordinary sound experience to your home entertainment system. We encourage you to take a few minutes to read through this manual, which describes the product and includes step-by-step instructions for setting up and getting started.

To make the most of product features and support, you may need to update the product software through the USB connector in the future. Refer to the software update section in this manual to ensure that your product has the latest software.

Designs and specifications are subject to change without notice. If you have any questions about the soundbar, installation or operation, please contact your retailer or customer service representative, or visit our website: www.jbl.com.

2 WHAT'S IN THE BOX

Unpack the box carefully and ensure that the following parts are included. If any part is damaged or missing, do not use it and contact your retailer or customer service representative.

Main unit



Subwoofer

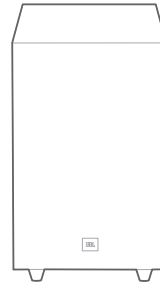

Remote control (with 2 AAA batteries)

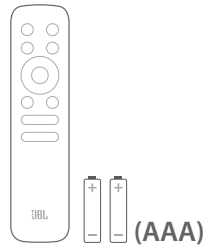

Power cord*

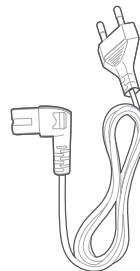

* Power cord quantity and plug type vary by region.

HDMI cable



Wall-mounting kit

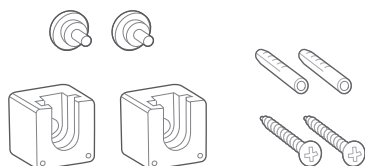

Product information & wall-mounting template



3 PRODUCT OVERVIEW

3.1 Controls and indicators

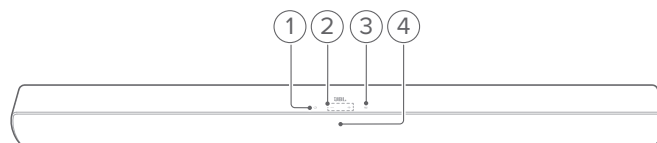

1. **⏻ (Power)**
 - Switch on or to standby
2. **-/+ (Volume)**
 - Decrease or increase the volume
 - Press and hold to decrease or increase the volume continuously
 - Press the two buttons together to mute or unmute
3. **🔄 (Source)**
 - Select a sound source: **Bluetooth** (default) or **HDMI ARC** (TV connected through the **HDMI ARC** connector), or **Optical** (TV / digital device connected through the **OPTICAL** connector)

4. Status indicators

●	Solid red	Entering standby mode
●	Solid amber	Subwoofer connected Optical source selected
○	Solid white	HDMI ARC source selected
●	Solid blue	Connected to Bluetooth
⚙️	Fast flashing blue	Entering Bluetooth pairing mode
\	Flashing (current sound source)	Volume change ongoing
\	Slow flashing (current sound source)	Maximum / minimum volume level reached
\	Continuous slow flashing (current sound source)	Sound muted

3.2 Connectors

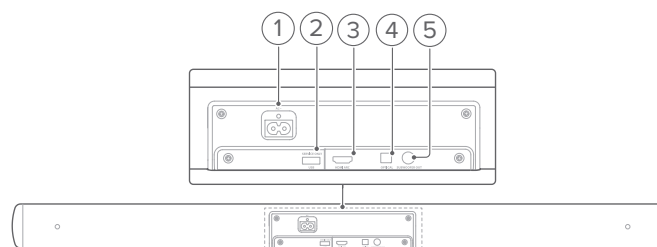

1. **AC~**
 - Connect to power
2. **USB**
 - USB connector for software update
 - Connect to a USB storage device for audio play (for the US version only)

3. HDMI ARC

- Connect to the HDMI ARC input on your TV

4. OPTICAL

- Connect to the optical output on your TV or digital device

5. SUBWOOFER OUT

- Connect to the subwoofer plug

3.3 Subwoofer

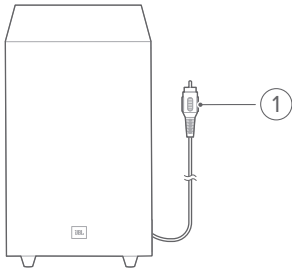

1. Subwoofer plug

- Connect to the **SUBWOOFER OUT** socket on the soundbar

3.4 Remote Control

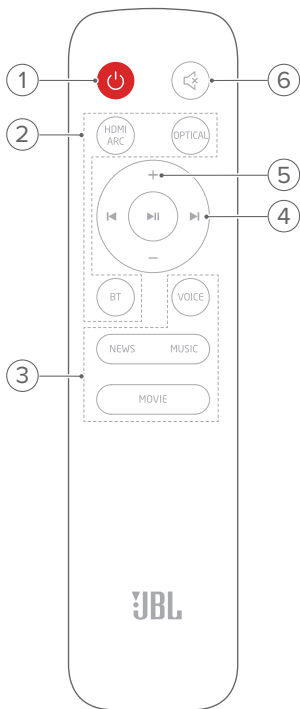

1.

- Switch on or to standby

2. Source selectors

HDMI ARC

- Select the HDMI ARC source

OPTICAL

- Select the Optical source

BT

- Select the Bluetooth source
- Press and hold to connect another Bluetooth device

3. Sound effect buttons

NEWS / MUSIC / MOVIE

- Select the pre-defined EQ (equalizer) settings for news/ music/ movie

VOICE

- Select the voice mode to enhance vocal clarity

4. Playback buttons

- Bluetooth source: Skip to the previous or next track

- Bluetooth source: Start or pause playback

5. + / -

- Increase or decrease the volume
- Press and hold to increase or decrease the volume continuously.

6. (Mute)

- Mute/unmute

4 PLACE

4.1 Desktop placement

Place the soundbar and subwoofer on a flat and stable surface. Make sure that the subwoofer is at least 3 ft (1 m) away from the soundbar, and 4" (10 cm) away from a wall.

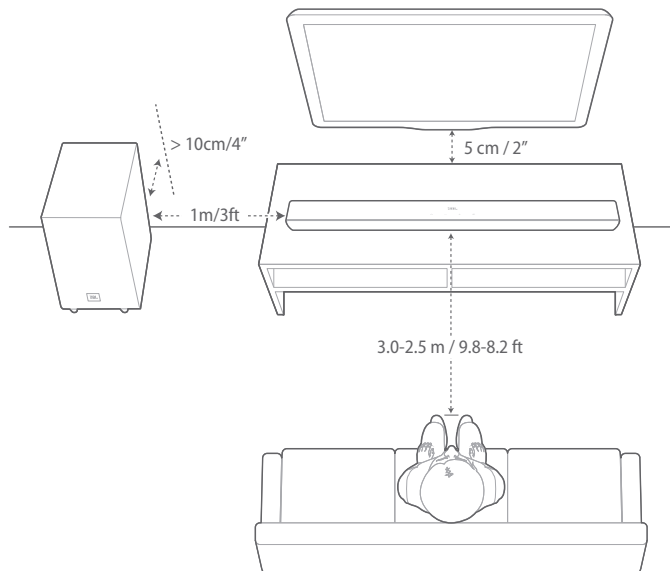

NOTES:

- The power cord shall be properly connected to power.
- Do not place any objects on the top of the soundbar or subwoofer.

4.2 Wall-mounting

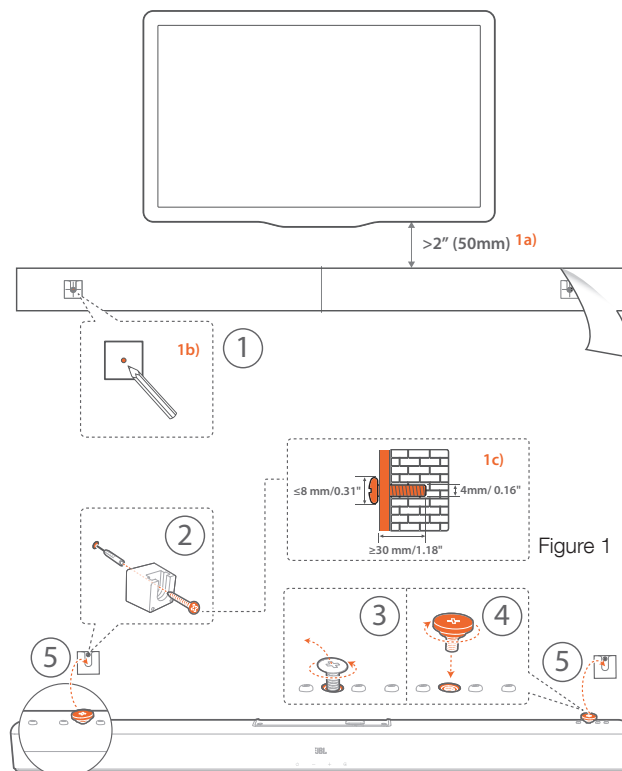

Figure 1

1. Preparation:
 - a) With a minimum distance of 2" (50mm) from your TV, stick the supplied wall-mounting template to a wall by using adhesive tapes.
 - b) Use your ballpen tip to mark the screw holder location. Remove the template.
 - c) On the marked location, drill a 4 mm/0.16" hole. Refer to Figure 1 for the screw size.
2. Install the wall-mounting bracket.
3. As shown in the diagram, remove the fastening screw by using a screwdriver.
4. Fasten the wall-mounting screw included in the supplied mounting kit.
5. Mount the soundbar.

NOTES:

- Make sure that the wall can support the weight of the soundbar.
- Install on a vertical wall only.
- Avoid a location under high temperature or humidity.
- Before wall-mounting, make sure that cables can be properly connected between the soundbar and external devices.
- Before wall-mounting, make sure that the soundbar is unplugged from power. Otherwise, it may cause an electric shock.

5 CONNECT

5.1 TV connection

Connect the soundbar with your TV through the supplied HDMI cable or an optical cable (sold separately).

Through the supplied HDMI cable

An HDMI connection supports digital audio and video with a single connection. HDMI connectivity is the best option for your soundbar.

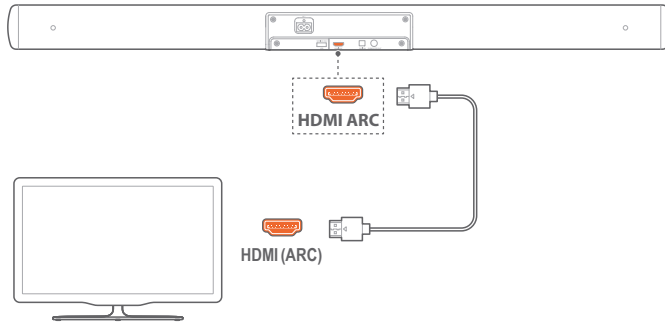

1. Connect the soundbar with your TV by using the supplied HDMI cable.
2. On your TV, check that HDMI-CEC and HDMI ARC have been enabled. Refer to the owner's manual of your TV for more information.

NOTES:

- Full compatibility with all HDMI-CEC devices is not guaranteed.
- Contact your TV manufacturer if you have problems with the HDMI-CEC compatibility of your TV.

Through an optical cable

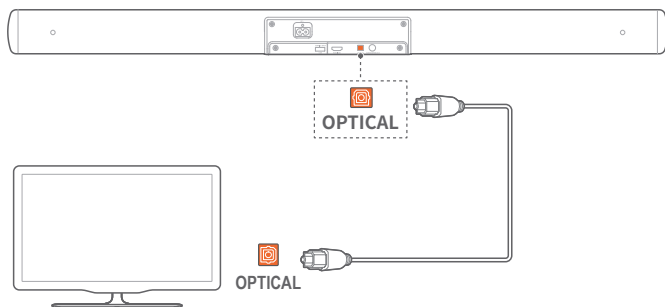

- Connect the soundbar with your TV by using an optical cable (sold separately).

5.2 Bluetooth connection

Through Bluetooth, connect the soundbar with your Bluetooth device, such as a smartphone, tablet and laptop.

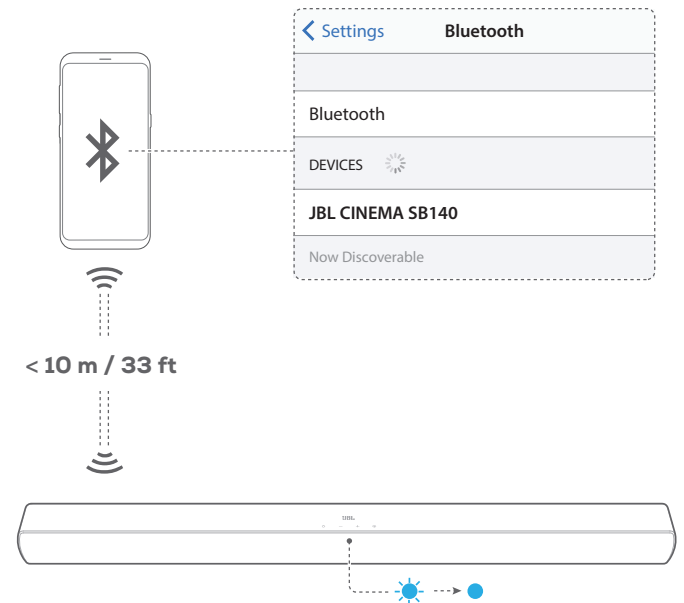

Connect a Bluetooth device

1. Press \mathcal{U} to switch on (See "6.1 Power-on/Auto standby/Auto wakeup" in the "6 PLAY" chapter).
2. To select the Bluetooth source, press \mathcal{G} on the soundbar or \mathcal{B} on the remote control.
 - Ready for pairing: The status indicator flashes blue.
3. On your Bluetooth device, enable Bluetooth and search for "JBL CINEMA SB140" within three minutes.
 - Connected: The status indicator lights up solid blue. A confirmation tone is heard.

To reconnect the last paired device

Your Bluetooth device is retained as a paired device when the soundbar goes to standby mode. Next time you switch to the Bluetooth source, the soundbar reconnects the last paired device automatically.

To connect to another Bluetooth device

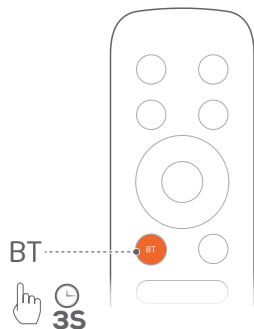

1. In the Bluetooth source, press and hold **G** on the soundbar or **BT** on the remote control until the status indicator flashes blue.
→ The soundbar enters the Bluetooth pairing mode. The status indicator flashes blue.
2. Follow Step 3 under “Connect a Bluetooth device”.
 - If the device has ever been paired with the soundbar, first unpair “**JBL CINEMA SB140**” on the device.

NOTES:

- The Bluetooth connection will be lost if the distance between the soundbar and Bluetooth device exceeds 33 ft (10 m).
- Electronic devices may cause radio interference. Devices that generate electromagnetic waves must be kept away from the soundbar, such as microwaves and wireless LAN devices.

6 PLAY

6.1 Power-on/Auto standby/Auto wakeup

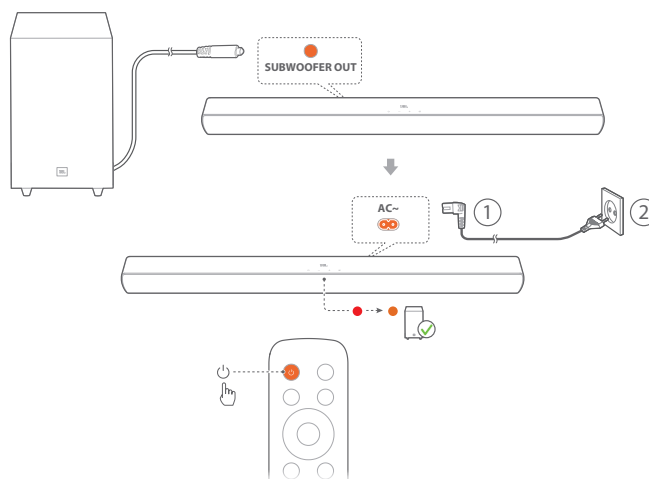

Switch on

1. Connect the subwoofer with the soundbar by inserting the subwoofer plug into the **SUBWOOFER OUT** jack on the soundbar.
2. Connect the soundbar to power by using the supplied power cord.
3. Press **⏻** to switch on.
→ The subwoofer is connected to the soundbar automatically.
Connected: The connection status indicator turns solid amber (●).

NOTES:

- Use the supplied power cord only.
- Before switching on the soundbar, make sure that you have completed all other connections (See “5.1 TV connection” in the “5 CONNECT” chapter).

Auto standby

If the soundbar is inactive for more than 10 minutes, it will switch to standby mode automatically. Next time you switch on the soundbar, it returns to the last selected source.

Auto wakeup

In standby mode, the soundbar will wake up automatically when

- the soundbar is connected to your TV through the HDMI ARC connection and your TV is switched on;
- the soundbar is connected to your TV through an optical cable and audio signals are detected from the optical cable.

6.2 Play from the TV source

With the soundbar connected, you can enjoy TV audio from the soundbar speakers.

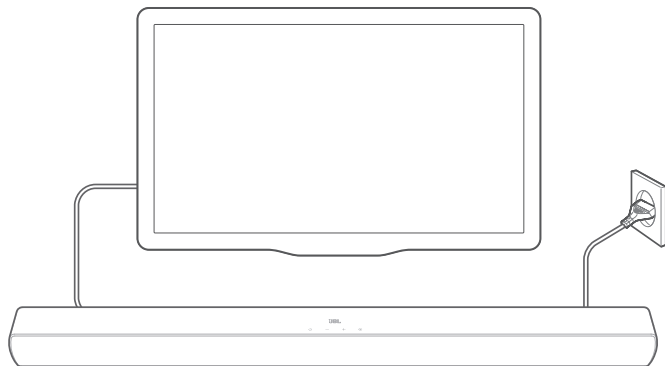

1. Make sure that your TV is set to support external speakers and the built-in TV speakers are disabled. Refer to the owner's manual of your TV for more information.
2. Make sure that the soundbar has been properly connected to your TV (See "5.1 TV connection" in the "5 CONNECT" chapter).
3. To select the TV source, press **⏮** on the soundbar or **HDMI ARC / OPTICAL** on the remote control.
 - The status indicator turns solid white (○), if your TV is connected to the soundbar through the **HDMI ARC** connector.
 - The status indicator turns solid amber (●), if your TV is connected to the soundbar through the **OPTICAL** connector.

6.2.1 TV remote control setup

To use your TV remote control for both your TV and the soundbar, check that your TV supports HDMI-CEC. If your TV does not support HDMI-CEC, follow the steps under "TV remote control learning".

HDMI-CEC

If your TV supports HDMI-CEC, enable the functions as instructed in your TV user manual. You can control the volume +/-, sound source, and power on/standby functions on your soundbar through the TV remote control.

TV remote control learning

Through IR learning, your Infra-red TV remote control can learn some commands of the soundbar.

1. Check that you have switched the soundbar to standby mode.
2. On the soundbar, press and hold **⏮** and **+** until the status indicator flashes amber.
 - You enter the TV remote control learning mode.

3. Within seconds, do the following on the soundbar and your TV remote control:
 - a) On the soundbar: press and hold one of the following buttons: **+**, **-**, **⏮** and **⏭**, until the status indicator flashes red three times.
 - b) On your TV remote control: double press the desired button.
 - When the status indicator flashes amber on the soundbar, the function of the soundbar button is learnt by your TV remote control button.
4. Repeat Step 3 to complete the button learning.
5. To exit the TV remote control learning mode, press and hold **⏮** and **+** on the soundbar until the status indicator flashes amber three times.

6.3 Play from the Bluetooth source

Through Bluetooth, stream audio from your Bluetooth device to the soundbar.



1. Check that the soundbar has been properly connected to your Bluetooth device (See "5.2 Bluetooth connection" in the "5 CONNECT" chapter).
2. To select the Bluetooth source, press **⏮** on the soundbar or **📶** on the remote control.
3. Start audio play on your Bluetooth device.
4. Adjust the volume on the soundbar or your Bluetooth device.

7 SOUND SETTINGS

7.1 Pre-defined EQ settings

With the remote control, select the pre-defined Equalizer (EQ) settings for your audio playback.

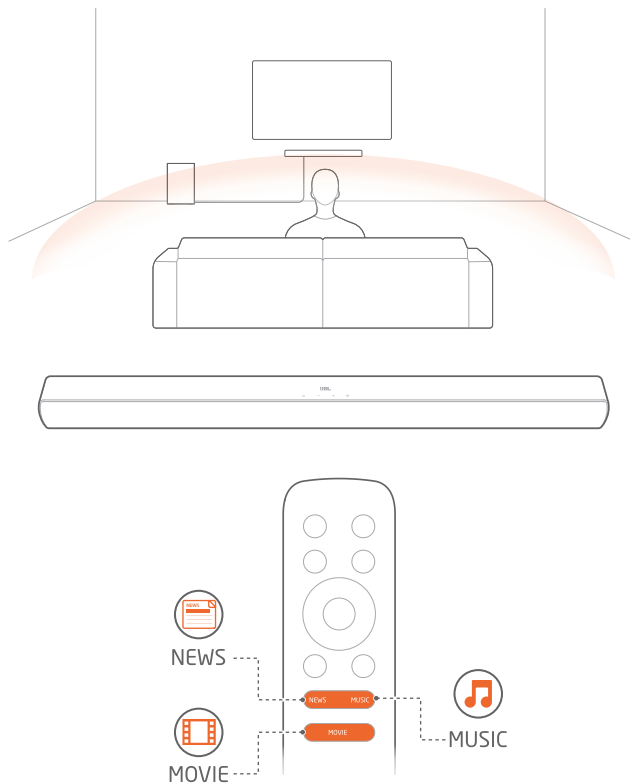

MUSIC: sound mode for music

MOVIE: sound mode for movies

NEWS: sound mode for TV programs such as news and weather forecasts

7.2 Voice mode

With the voice mode, vocal clarity is enhanced to allow you to easily hear and understand speech.

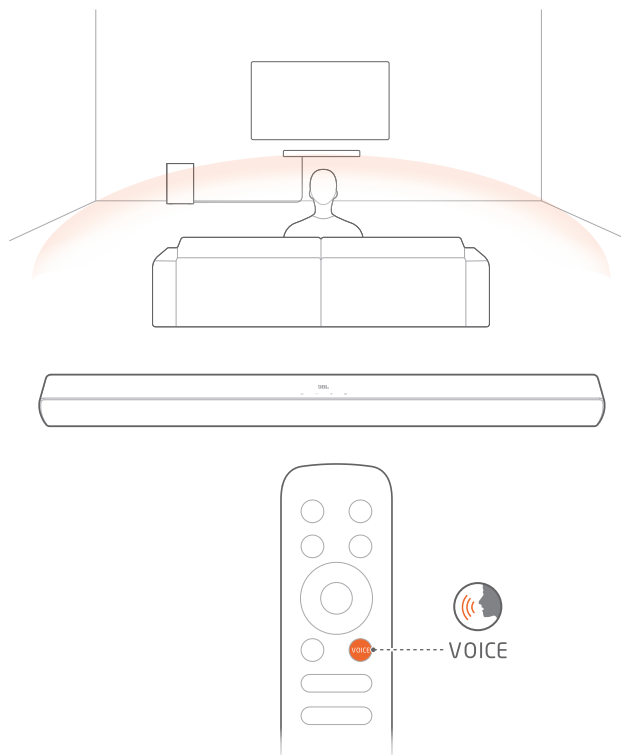

- On the remote control, press **VOICE** to select the voice mode.

8 RESTORE FACTORY SETTINGS

By restoring the default settings defined at factories, you remove all your personalized settings from the soundbar.

- On the soundbar, press and hold \cup and G for more than 10 seconds.

9 SOFTWARE UPDATE

For optimal product performance and your best user experience, JBL may offer software updates for the soundbar system in the future. Please visit www.jbl.com or contact JBL call center to receive more information about downloading update files.

1. Check that you have saved the software update file to the root directory of a USB storage device. Connect the USB device to the soundbar.
 - Make sure that your USB storage device meets the following requirements:
 - Maximum capacity: 64 GB
 - File system: FAT32

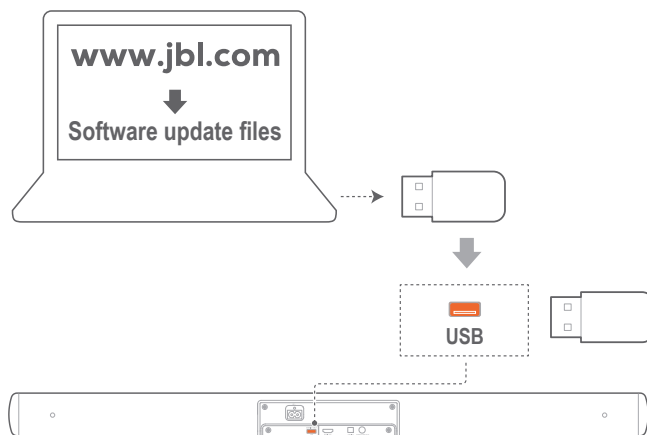

2. To enter the software update mode,
 - a) check that you have switched the soundbar to standby mode.
 - b) press and hold \cup and $-$ on the soundbar for more than 10 seconds.
 - \circ \bullet \bullet \bullet \bullet : software updating in progress
 - \bullet : software updating complete
 - The soundbar returns to standby mode.

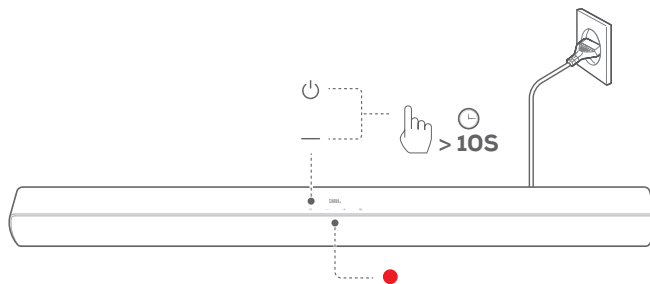

NOTES:

- Keep the soundbar powered on and the USB storage device mounted before software updating is complete.

10 PRODUCT SPECIFICATIONS

General specification:

- Power supply: 100 - 240 V~, 50/60 Hz
- Total speaker power output (Max. @THD 1%): 110 W
- Soundbar power output (Max. @THD 1%): 2 x 27 W
- Subwoofer power output (Max. @THD 1%): 56 W
- Soundbar transducer: 2x 2" full range driver
- Subwoofer transducer: 4", wired sub
- Standby consumption: 0.5 W
- Operating temperature: 0°C - 45°C

HDMI specification:

- HDMI Video output (With Audio return channel): 1
- HDMI HDCP version: 1.4

Audio specification:

- Frequency response: 40 Hz - 20 kHz
- Max SPL: 82 dB
- Audio inputs: 1 Optical, Bluetooth, USB (USB playback is available in US version. For other versions, USB is for Service only.)

USB specification:

- USB port: Type A
- USB rating: 5 V DC / 0.5 A
- Supporting file format: mp3
- MP3 Codec: MPEG 1 Layer 1/2/3, MPEG 2/2.5 Layer 1/2/3
- MP3 sampling rate: 8 kHz - 48 kHz
- MP3 bitrate:
 - MPEG 1 Layer 1: 32 kbps - 448 kbps;
 - MPEG 1 Layer 2: 32 kbps - 384 kbps;
 - MPEG 1 Layer 3: 32 kbps - 320 kbps;
 - MPEG 2/2.5 Layer 1: 32 kbps - 256 kbps;
 - MPEG 2/2.5 Layer 2/3: 8 kbps - 160 kbps

Wireless specification:

- Bluetooth version: 4.2
- Bluetooth profile: A2DP V1.3, AVRCP V1.5
- Bluetooth frequency range: 2402 - 2480 MHz
- Bluetooth Max. transmitting power: < 0 dBm (EIRP)
- Bluetooth modulation: GFSK, π/4 DQPSK

Dimensions:

- Dimensions (W x H x D):
 - 900 x 62 x 67.5 mm / 35.4" x 2.44" x 2.66" (soundbar);
 - 170 x 275 x 240 mm / 6.7" x 10.82" x 9.45" (subwoofer)
- Weight: 1.5 kg (soundbar); 2.7 kg (subwoofer)
- Packaging dimensions (W x H x D):
 - 995 x 205 x 375 mm / 39.17" x 8.07" x 14.76"
- Packaging weight (Gross weight): 6.0 kg

11 TROUBLESHOOTING

Never try to repair the product yourself. If you have problems using this product, check the following before you request services.

System

The unit will not turn on.

- Check if the power cord is plugged into power and the soundbar.

The soundbar has no response to button pressing.

- Restore the soundbar to factory settings (See the "8 RESTORE FACTORY SETTINGS" chapter).

Sound

No sound from the soundbar

- Make sure that the soundbar is not muted.
- Select the correct audio input source on the remote control.
- Connect the soundbar to your TV or other devices properly.
- Restore the soundbar to its factory settings by pressing \odot and C on the soundbar for more than 10 seconds.

Distorted sound or echo

- If you play audio from your TV through the soundbar, make sure that your TV is muted or the built-in TV speaker is disabled.

Bluetooth

A device cannot be connected with the soundbar.

- Check if you have enabled Bluetooth on the device.
- If the soundbar has been paired with another Bluetooth device, reset Bluetooth (see "To connect to another Bluetooth device" under "5.2 Bluetooth connection").
- If your Bluetooth device has ever been paired with the soundbar, reset Bluetooth on the soundbar, unpair the soundbar on the Bluetooth device, and then, pair the Bluetooth device with the soundbar again (see "To connect to another Bluetooth device" under "5.2 Bluetooth connection").

Poor audio quality from a connected Bluetooth device

- The Bluetooth reception is poor. Move the source device closer to the soundbar, or remove any obstacle between the source device and the soundbar.

The connected Bluetooth device connects and disconnects constantly.

- The Bluetooth reception is poor. Move the source device closer to the soundbar, or remove any obstacle between the source device and the soundbar.
- For some Bluetooth devices, the Bluetooth connection can be deactivated automatically to save power. This does not indicate any malfunction of the soundbar.

Remote control

The remote control does not work.

- Check if the batteries are drained. If so, replace them with new ones.
- Reduce the distance and angle between the remote control and the main unit.

Failed to complete the TV remote control learning.

- Check if you are using an infra-red TV remote control. The IR learning is not supported by a Bluetooth TV remote control.

12 TRADEMARKS



The Bluetooth® word mark and logos are registered trademarks owned by Bluetooth SIG, Inc. and any use of such marks by HARMAN International Industries, Incorporated is under license. Other trademarks and trade names are those of their respective owners.



The terms HDMI, HDMI High-Definition Multimedia Interface, and the HDMI Logo are trademarks or registered trademarks of HDMI Licensing Administrator, Inc.



Manufactured under license from Dolby Laboratories. Dolby, Dolby Audio, and the double-D symbol are trademarks of Dolby Laboratories Licensing Corporation.



HARMAN International Industries,
Incorporated 8500 Balboa Boulevard,
Northridge, CA 91329 USA
www.jbl.com

© 2021 HARMAN International Industries, Incorporated.
All rights reserved.

JBL is a trademark of HARMAN International Industries, Incorporated, registered in the United States and/or other countries. Features, specifications and appearance are subject to change without notice.